



## 06 High current carbon brushes



Transmission systems with linear adjustable  
telescope holders  
p. 05

Transmission systems with "Kombi" holders  
p. 09

Further transmission systems  
p. 13

# High current carbon brushes

## Flexible solutions

For the transmission of high loads carbon brush systems of metallic carbon graphite grades together with the suitable brush holders are selected.

Both, standardized and special constructions, that have been developed together with our customers, are operating. We reconcile our products with the multiple range of applications, and take the individual requests of our customers into consideration. We prefer a close contact with our customers during the phase of design and development, thus we achieve top solutions with regard to load conditions, selection of material, operating characteristics and life time of the load transmission systems.

Due to our flexible production line manifold requests, also for smaller quantities, can be realized in a high quality standard at reasonable costs.

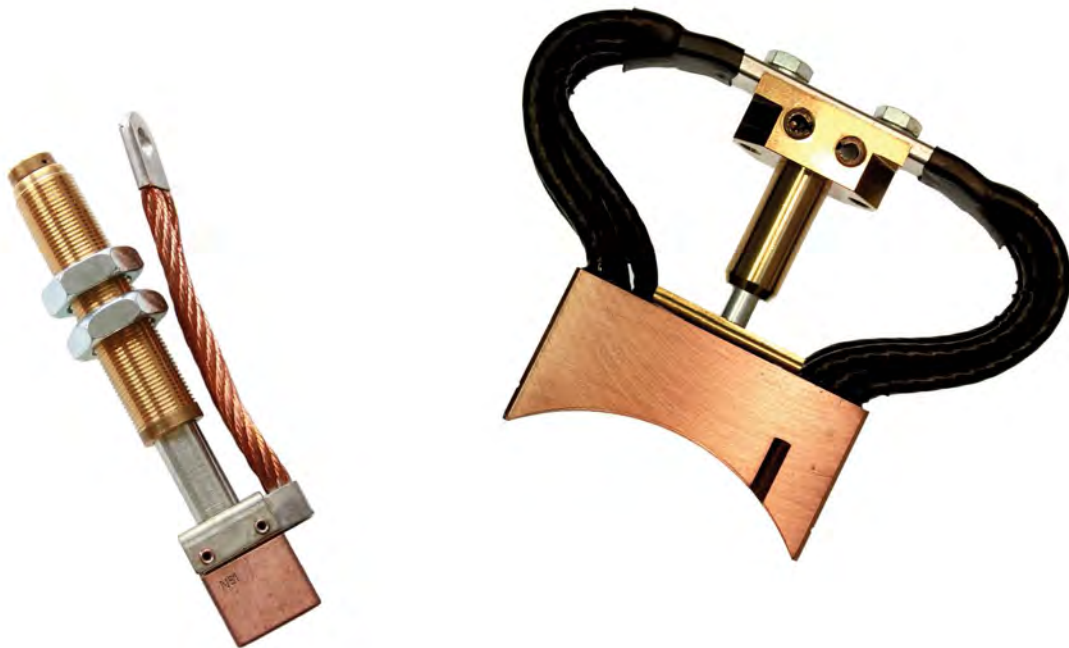

## Special selection of material

Transmission of very high loads requires specially developed carbon materials with a high metal content. We recommend our high metal carbon grades, made in a special hot pressing process. With such grades high load transmissions with admissible current densities of up to 40 Amps/cm<sup>2</sup> are possible.

High load carbon contacts consist of non-iron metals with graphite, which are machined from a block shaped semiproduct (based on a powder metallurgic process)

The brush holder systems are made from brass or cast bronze. These parts are either machined from commercial semiproducts or made by a die-casting process.

Corrosion protective constructions by means of surface refinement, are already being realized in numerous performances, in particular under aggressive environmental conditions (acid, vapours, drawing emulsion and condensates).

## Technical performance

The high load carbon brushes and their holders are exposed to extreme operating conditions. Dimensioning must correspond to the high load transmissions. The contact area has to be very large, as to minimize voltage drop (in particular under low voltage) and to guarantee also a good thermal dissipation. A selective number of smaller instead of a few larger dimensioned brushes (brush cross section  $\text{cm}^2$ ) has always proved successful.

We recommend for high load current transmission our grades N51, N55, and 0555.

In case of multiple carbon brushes in parallel a load reduction of 10 to 15 % per carbon brush is recommended. Peak loads should be applied only on slow moving equipment. If also thermique load in a brush exists (i.e stored heat), the cross section of brush should be additionally enlarged.

The sliding bars in high load transmission must be clean, smooth. Damaged parts have to be repaired and polished, excessive patina to be removed with thinner.

Only good conditioned slides and slip rings guarantee a trouble-free performance.

Regular maintenance is necessary.



Welding robot



Surface refinement



Welding equipment

## Main fields of application:

- › Welding equipment and robots
- › Electrolytic lamination of metals
- › Surface refinement of metal sheets in rolling mills
- › Copper plating of rotogravure cylinder
- › General plating of surface refinement, i.e. tinning, nickel-plating, chromium-plating
- › Automatic antirust protection
- › Electropheric treatment in the car industry and thin sheet technique
- › All high load transmissions, wire annealing, etc.



## High current carbon brushes





## Transmission systems with linear adjustable telescope holders

Such current transmission systems are freely suspended and can easily adapt to the slide or ring. A pressure spring in the holder box is transmitting pressure on to the brush. Brush contact shapes with or without radius will be done to customer's request. The fastening is either done on a bus bar or on a brush yoke. The holders can be assembled space-saving, and offer many variations.

### High current brushes for telescope holders

These high current brushes are rated for loads up to 800 Amps max.

Preferred carbon grade is N51. Its special composition and its special manufacturing process guarantee very good running conditions, and a perfect adaptation on the ring or slide.

Very high current densities of up to 40 Amps/cm<sup>2</sup> can be transmitted through relatively small contact areas. However, if extreme thermal conditions prevail, the cross section of the contact area should be approximately 25 % larger.

Peripheral speeds of up to 25 m/sec are possible.

### Telescope holders

The telescope holders for such high current carbon brushes are made in different variations and materials. You will find suitable telescope holders for numerous applications among our range.

The fastening should be done with an insulated holding device (avoids spark erosion in the holder, the current should be transmitted via pig tail), with a bore diameter of 22 mm. With the two supplied nuts a linear adaptation of the carbon brush system is possible. Telescope holders with spring pressures of either 50 N or 100 N are available. We recommend a brush pressure of 2,5 – 4 N/cm<sup>2</sup>. When selecting the spring pressure, the chosen brush grade, the brush cross section (cm<sup>2</sup>) and the peripheral speed must be taken into consideration.



# Transmission systems with linear adjustable telescope holders

## High current carbon brushes

Standard versions



Pict.	1	2	3	4	5	6
Type	J4108	J5369	J6111	J6282	J3967	J4767

The length and the material (bare or tinned, with or without insulation) of the pig tails can be ordered to customer's request.

Further modifications of physical dimensions and material are negotiable.

Pict.	Type	Dimensions in mm	Standard grade	Admissible load in Amps	Design armature/pig tail	Suitable holders
1	J4108	30x30x23/30	N51	315	Riveted design with 2 pig tails, 1 terminals, without tapped bush	T...-50N-d7,5
1	J4108/1	30x30x28/30	E-Cu57	400	Riveted design with 2 pig tails, 1 terminals, without tapped bush	T...-50N-d7,5 T...-100N-d7,5
1	J4323	40x30x31/38	N51	200	Riveted design with 2 insulated pig tails, 1 terminals, without tapped bush	T...-50N-d7,5 T...-100N-d7,5
2	J5369	45x30x35/41	2454	330	Riveted design with 2 pig tails, 1 terminals, tapped bush	T...-50N-d7,5 T...-100N-d7,5
3	J6111	38x40x23/30	N51	530	Riveted design with 4 pig tails, 2 terminals, without tapped bush	T...-50N-d7,5 T...-100N-d7,5
3	J6111/1	40x40x28/30	E-Cu57	750	Riveted design with 4 pig tails, 2 terminals, without tapped bush	T...-50N-d7,5 T...-100N-d7,5
3	J5224	38x38x40/46	N51	500	Riveted design with 4 insulated pig tails, 2 terminals, tapped bush	T...-50N-d7,5 T...-100N-d7,5
4	J6282	70x30x40/46	N51	730	Riveted design with 4 pig tails, 2 terminals, tapped bush	T...-50N-d7,5 T...-100N-d7,5
5	J3967	55x40x45/51	N51	770	Riveted design with 4 pig tails, 2 terminals, tapped bush	T...-50N-d7,5 T...-100N-d7,5
5	J4536	50x40x45/51	N51	700	Riveted design with 4 pig tails, 2 terminals, tapped bush	T...-50N-d7,5 T...-100N-d7,5
5	J5085	55x40x40/46	N51	770	Riveted design with 4 pig tails, 2 terminals, tapped bush	T...-50N-d7,5 T...-100N-d7,5
6	J4767	50x40x45/56	N51	700	Riveted design with 2 flexible connections, tapped bush	T...-50N-d7,5 T...-100N-d7,5

## Linear adjustable telescope holders

Standard versions



Pict. 1 2 3 4 5 6

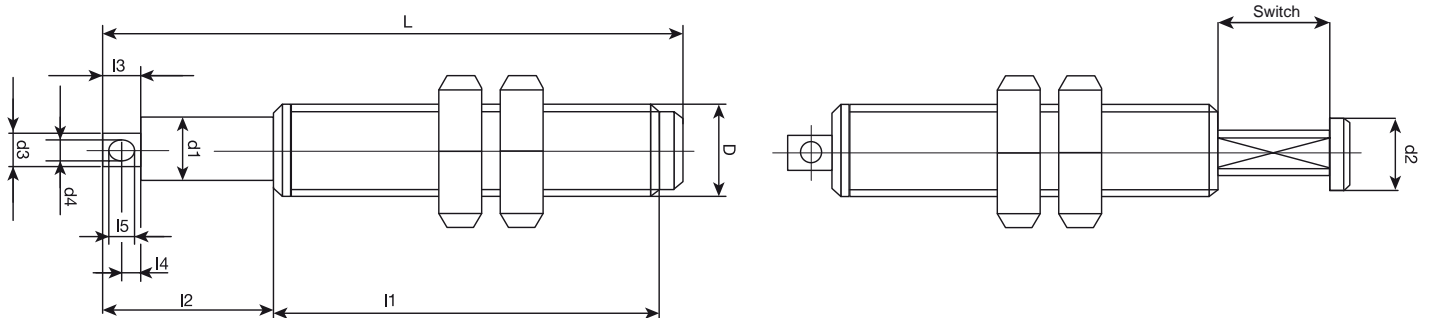

Pict.	Type	Spring	Stroke	L	l1	l2	l3	l4	l5	D	d1	d2	d3	d4	Remark
1	T149-50N-d16/M	50 N	27	149	95	48			6	M22x1,5	16	17		6	
2	T143-50N-d7,5	50 N	30	143	95	44	10	4	4,2	M22x1,5	16	17	7,5	4,2	
2	T143-50N-d7,5/F2	50 N	30	143	95	44	10	4	4,2	M22x1,5	16	17	7,5	4,2	2 guide surfaces
3	T118-50N-d7,5	50 N	20	118	85	28	10	4	4,2	M22x1,5	16	17	7,5	4,2	
5	T107-50N-d7,5/F2	50 N	23	107	67	36	12	6	4,2	M22x1,5	16	17	7,5	4,2	2 guide surfaces, protection cap
5	T107-50N-d7,5/F2EBF	50 N	23	107	67	36	12	6	4,2	M22x1,5	16	17	7,5	4,2	2 guide surfaces, protection cap
4	T80-50N-d7,5	50 N	15	80	49	25	10	4	4,2	M22x1,5	16	17	7,5	4,2	
6	T100-35N-d6	35 N	22	100	67	30	7	4	3	M16x2,0	11	13	6	3	Guide slot
1	T149-100N-d16M	100 N	27	149	95	48			6	M22x1,5	16	17		6	
2	T143-100N-d7,5	100 N	30	143	95	44	10	4	4,2	M22x1,5	16	17	7,5	4,2	

Further types:

.../F2 = mandrel with 2 guide surfaces | .../M = with Ms mandrel

.../E = with stainless steel spring | .../EBF = with stainless steel mandrel and spring



## High current carbon brushes





## Transmission systems with “Kombi” holders

Transmission systems with “Kombi” holders are freely suspended, and can easily adapt to the slipring. A pressure spring in the holder box is transmitting the pressure onto the brush. The brush contact shape with or without radius will be done according to customer's request. The fastening is either done on a bus bar or on brush yoke. The holder can be assembled space-saving.



### High current carbon brushes

The high current carbon brushes are rated for loads from 700 Amps till 1700 Amps (standard versions). Also possible are special constructions, with or without water cooling for extremely high load conditions.

High current carbon brushes are mainly made from high metallic graphite materials. Their specific compositions and their special manufacturing process guarantee very good running behaviour, and perfect adaptation on slip rings.

Very high current densities of up to 40 Amps/cm<sup>2</sup> can be transmitted through small contact areas. However, if extreme thermal conditions prevail, the cross section of the contact area should be about 30 % higher.

High peripheral speeds of up to 25 m/sec are possible.

### “Kombi” holders

“Kombi” holders for these high current carbon brushes are produced in numerous variations, and materials. The fastening of the such holders is done by screwing them on bus bars or brush yokes. The pig tails of the high current carbon brush will be clamped into the guide slots between “Kombi” holder and bus bar. Telescope holders with 60 NB till 150 N spring force are available. We recommend a brush pressure of 2,5 – 4 N/cm<sup>2</sup>. When selecting the spring pressure, the chosen grade, the brush cross section, and the peripheral speed must be taken into consideration.

# Transmission systems with “Kombi” holders

## High current carbon brushes

Standard versions

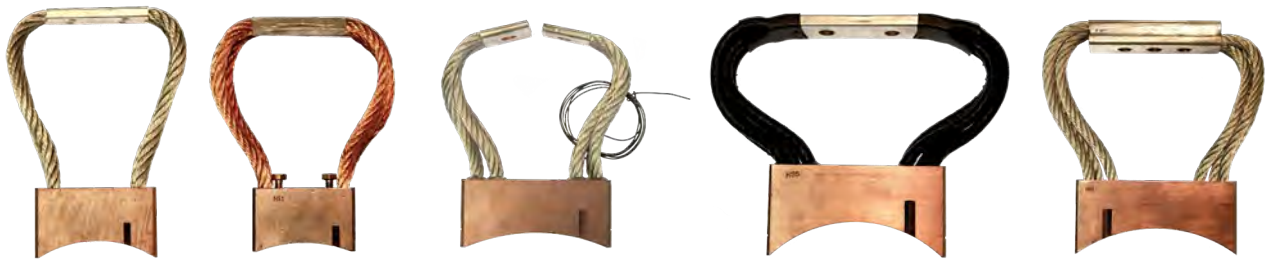

Pict.	1	2	3	4	5
Type	J4737	J5707	J4593	J5560	J6162

The pig tails are available in bare or tinned version, with and without insulation.

Further modifications of physical dimensions and material are negotiable.

Pict.	Type	Dimensions in mm	Standard grade	Admissible load in Amps	Design armature/pig tail	Suitable holders
1	J4492	70x36x32	N55	880	4 bare pig tails, without radius	TV92-15-70/01 TH92-15-60/01
1	J4737	70x36x40	N55	880	4 insulated, tinned pig tails, radius	TV92-15-70/01 TH92-15-60/01
1	J5170	70x36x40	N51	880	4 bare pig tails, radius	TV92-15-70/01 TH92-15-60/01
1	J5236	70x36x40	N51	880	4 tinned pig tails, radius	TV92-15-70/01 TH92-15-60/01
	J5236/1	70x36x45	N51	880	radius	TH92-15-60/01
1	J5237	70x36x40	N51	880	4 bare pig tails, longitudinal radius (no fig.)	TV92-15-70/01 TH92-15-60/01
2	J6114	65x48x40	N51	940	8 bare pig tails, radius	TV92-15-70/01 TH92-15-60/01
2	J5707	65x48x40	N51	940	8 bare pig tails, without radius	TV92-15-70/01 TH92-15-60/01
3	J4593/3M	100x36x45	N51	1250	8 tinned pig tails, alarm indicator cable, radius	TV92-15-100/02 TH92-15-110/02
4	J5932	118x40x54	N55	1600	10 insulated, tinned pig tails, radius	TV92-15-150/02 TH92-15-110/02
4	J6124	118x40x57	N55	1600	10 insulated, tinned pig tails, radius	TV92-15-150/02 TH92-15-110/02
4	J6328	118x40x60	N51	1600	10 tinned pig tails, radius	TV92-15-150/02 TH92-15-110/02
	J5844	118x40x60	N55	1600	radius	TH92-15-110/02
4	J6138	118x40x60	N55	1600	10 insulated, tinned pig tails, radius	TV92-15-150/02 TH92-15-110/02
	J5560	118x40x60	N55	1600	radius	TH92-15-110/02
5	J6162	118x40x60	N51	1600	double assembly plate, 10 tinned pig tails, radius	TV92-15-150/02 TH92-15-110/02

## “Kombi” holders

Standard versions

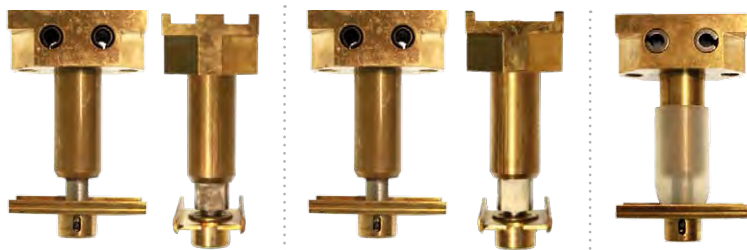

Pict. 1 2 3

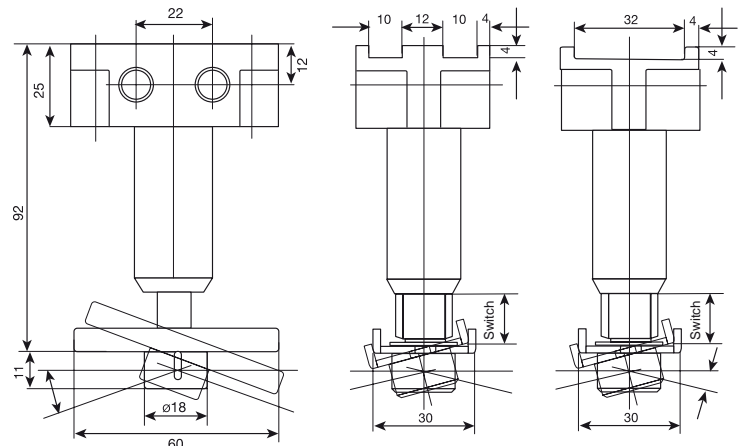

1 and 2 1 2

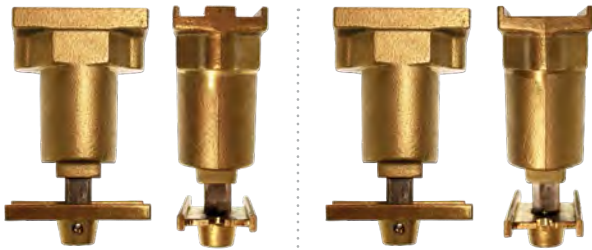

Pict. 4 5

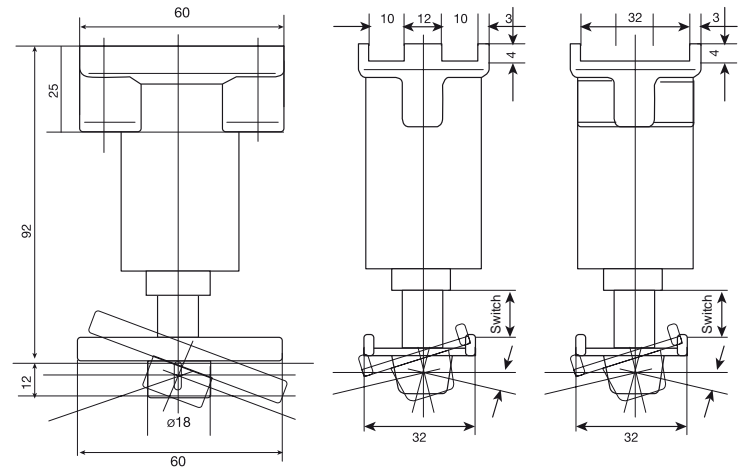

4 and 5 4 5

Pict.	Type	Design	Spring force	Hub	Remark
1	TV92/15-70/01	Socket with 2 guide grooves, solid brass material machined	60 N	14 mm	for brushes pict. 1 and 2
2	TV92/15-100/02	Socket with wide guide groove, solid brass material machined	100 N	14 mm	for brush pict. 3
2	TV92/15-150/02	Socket with wide guide groove, solid brass material machined	150 N	14 mm	for brushes pict. 4 and 5
3	To protect the tappet rod, “Kombi” holders of pict. 1 and 2 can be supplied with assembled protective cap.				
4	TH92/15-60/01	Socket with 2 guide grooves, cast bronze, massive design	60 N	14 mm	for brushes pict. 1 and 2
5	TH92/15-110/02	Socket with wide guide groove, cast bronze, massive design	110 N	14 mm	for brushes pict. 3 till 5



## High current carbon brushes



# Current transmission systems

Further examples of current transmitting systems with and without holders.



Pict. 1 2 3

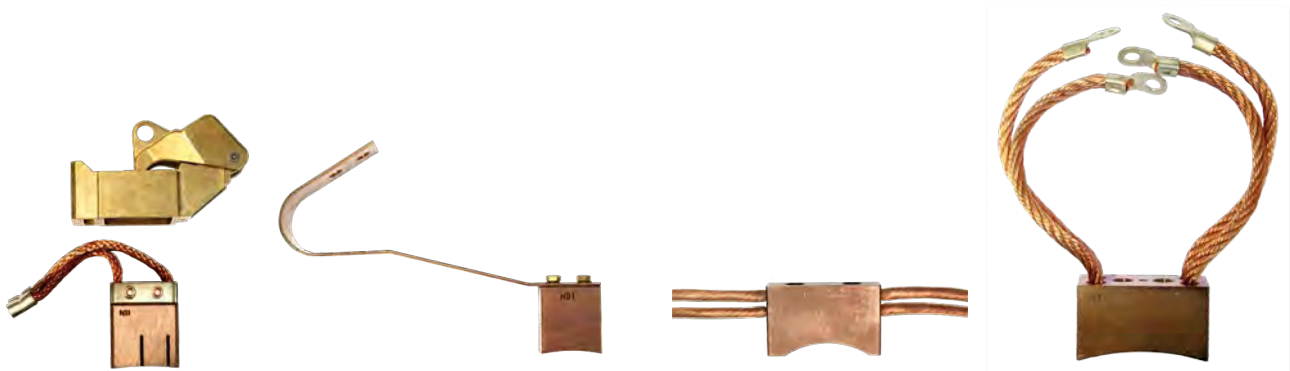

Pict. 4 5 6 7

We also gladly offer further designs of geometry and material.

We emphasize a close technical coordination with our customers during the developing and construction phase. Thus we achieve an optimal solution.

Pict.	Type	Dimension in mm	Grade	max. load in Amps	Remark
1	Brush/holder	2 brushes 40x20x40 mm, 2 pig tails, 2 terminals, double pocket holders 40x20, adjustable	N51	280 per brush	with and without alarm system
2	Brush/holder	2 brushes 40x32x50 mm, 4 pig tails, 2 terminals, double pocket holders 40x32, adjustable	N51	450 per brush	with and without alarm system
3	Brushholder bolt	Bolt for pict. 1 and 2 insulated 22 mm dia M16x24 mm	N51		in various lengths
4	Brush/holder	Brush 40x32x50 mm, 4 pig tails, 2 terminals, pocket holder 40x32, linear adjustable assembly	N51	450	with and without alarm system
5	Brush/holder	Brush 35x30x30 mm, 2 tapped bushes, Cu-Be clip for direct fastening	N51	340	in variable shapes
6	Brush	Brush 90x25x55 mm, 4 pig tails, 4 terminals	1503	780	in variable shapes
7	Brush	Brush 70x36x40 mm, 4 pig tails, 4 terminals	N55	880	in variable shapes



# High current carbon brushes

## Standard carbon grades

The carbon grades are based on non-ferrous metallic materials with graphite.

The selected high metallic carbon material, made in a hot pressing process is in particular suitable for high load transmission up to 40 Amps/cm<sup>2</sup> current density. Thanks to this special production process these grades have very low specific electrical resistances, and allow very good transmission values at high current densities.

The excellent sliding characteristics of grades N51, N55 and N91 permit very high current transmissions.

Grade	Specific resistance [Ohm × mm <sup>2</sup> /m]	Density [g/cm <sup>3</sup> ]	Bending strength [N/mm <sup>2</sup> ]	Rockwell hardness HR 10/40	Rated load [Amps/cm <sup>2</sup> ]	Speed [m/s]	Metal content [%]
1531	0,09	5	60	100	22	20	87
BR	0,1	4,9	55	100	22	20	85
2454	0,12	4,3	50	98	18	30	75
3402	0,15	4,2	40	95	16	35	70
3450	0,15	4	30	90	15	40	65
N51	0,1	5,5	30	60	40	25	90
N52	0,1	6,7	90	105	40	20	95,5
N55	0,06	6,6	85	90	40	20	95
N91	0,1	5,2	30	50	35	30	86
065	0,5	4	26	100	15	35	70

## Alarm indicator system

The brush control by means of an alarm indicator system guarantees an optimal operating security for the current transmission equipment.





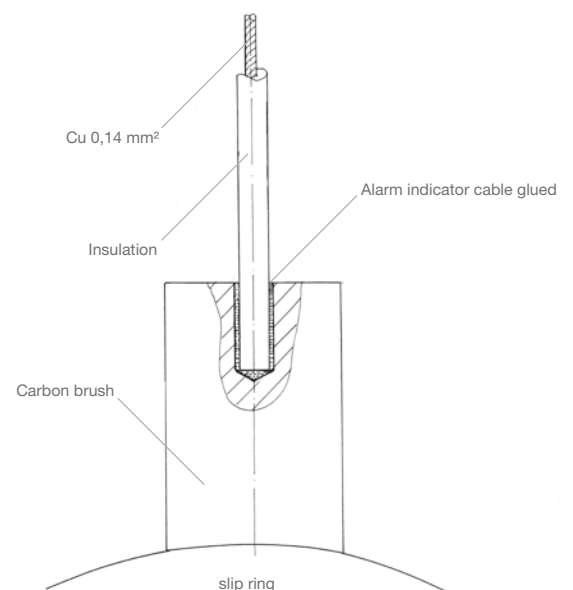





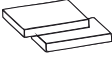







When fitting the high current carbon brushes with such an alarm device, a secure maintenance of the system is possible. The insulated indicator cable will be inserted and glued into the brush until the wanted alarm wear limit. The alarm contact is transferred from slipping on to the indicator cable, triggering either an optical signal or sound an alarm.

This system is saving volume, and offers additional security besides of an eventually existing wear mark.





# Our range of production

00	Carbon blocks	
01	Industrial carbon brushes	
02	Midget carbon brushes	
03	Micro carbon brushes	
04	Automotive carbon brushes	
05	Carbon contacts and carbon rolls	
06	High current carbon brushes	
07	Carbon inserts	
08	Carbon poles	
09	Carbon vanes	
10	Graphite lubricating brushes	
11	Carbon bearings	
12	Thermistors	
13	Special armatures for brushes	
14	Flexible copper conductors	
15	Carbon welding rods	
16	Carbon brushes for fork lift trucks	
17	Holders for carbon brushes	
18	Special carbon brushes	

## Schmidthammer Elektrokohle GmbH

Walpersdorfer Str. 33-39  
91126 Schwabach  
GERMANY

**Phone:** +49 (0)9122 - 18 06-0

**Fax:** +49 (0)9122 - 18 06-60

**E-Mail:** [mega@schmidthammer.com](mailto:mega@schmidthammer.com)

**Web:** [www.schmidthammer.com/en](http://www.schmidthammer.com/en)

